



WORLD VENTILATION LEADER



VENTILATION SYSTEMS
WWW.VENTILATION-SYSTEM.COM

ECO-VENTILATION



SINGLE-ROOM AIR HANDLING UNITS WITH HEAT RECOVERY



MicraClima
Single room air handling units with heat recovery

Fresh air
Energy saving
Compact size

Versatile
Easy mounting
Low noise

VENTS reserves the rights to modify any of its products' features, designs, components and specifications at any time and without notice to maintain the development and quality of manufactured goods.

06-2014



Fresh air in
your house!



VENTILATION ON OUR LIFE



How much fresh is the air we breathe in?

In everyday life, we do not think a lot about how much time we spend in closed spaces — houses, offices, office buildings, hospitals, etc. All this time we share limited volume of air of doubtful purity and freshness with our people in the same rooms. Unwellness, weariness, headache and other unpleasant symptoms are the first indicators of negative impact of polluted stale air on human health. Still, we rarely associate these conditions with poor air quality.

**For human organism,
the surrounding air quality
has vital importance**

The ventlight is not a good solution

Partially the polluted air problem can be solved by creating natural ventilation through window opening. Ventilation through open windows brings to uncontrolled excessive air flow and creates unsafe draughts. By opening windows you fill the room not with clean air but with a mixture of pollens, poplar stuff, dust and exhaust fumes. Moreover, thermal losses rise together with high energy costs. Furthermore, noise level from outside may be a catastrophe.

**We hardly make such ventilation useful but we let
extra irritants and pollutants enter our rooms and we do not
solve the problem of polluted stale air removal**

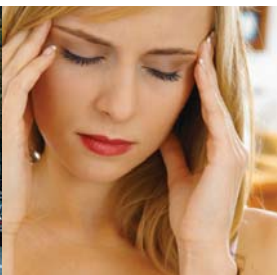

In captivity of our own houses...

modern houses made of brick and concrete, equipped with double-glazed windows, metal doors, additional outer insulation, etc., are practically hermetic structures.

Striving to minimize heat losses and energy costs has resulted in almost perfect insulation of buildings and blocked any possibility of natural air motion and air exchange. The rooms or premises that are thermally well insulated and sealed in plastic windows cannot avoid excessive moisture which provokes formation of various bad smells, including foul smell, feeling of stale air, various pollutants, even mould. Microclimate in this house becomes harmful for its inhabitants and for the house structure, too.

THERE IS A SOLUTION!

Arrangement of the effective
forced supply and exhaust
ventilation in the rooms or
premises.

SINGLE-ROOM AIR HANDLING UNITS

MICRA

THE BEST COST-SAVING SOLUTION FOR CREATING OF ENERGY SAVING VENTILATION OF SEPARATE ROOMS IN APARTMENTS, COTTAGES, SOCIAL AND COMMERCIAL PREMISES.

- ▶ CLEAN FRESH AIR SUPPLY TO THE PREMISES
- ▶ STALE EXTRACT AIR REMOVAL FROM THE PREMISE
- ▶ CLEAN AIR FREE OF DUST AND INSECTS
- ▶ NO EXCESSIVE HUMIDITY AND MOULD
- ▶ SILENT OPERATION
- ▶ HEAT REGENERATION
- ▶ AIR WARMING UP TO SET TEMPERATURE (MICRA 150 E)
- ▶ REDUCING HEATING COSTS IN WINTER AND AIR CONDITIONING COSTS IN SUMMER
- ▶ LOW ENERGY DEMAND
- ▶ NON-STOP OPERATION

▶ COST-SAVING

The single room air handling units with heat recovery **MICRA** are the fully-featured ready to use ventilation solutions that provide supply of fresh air to the premise, air filtration and extract of polluted air outside and supply air warming up if required (MICRA 150 E).

MICRA units create an effective and fully-fledged ventilation in your house!

▶ ENERGY SAVING AND EFFICIENCY

The great advantage of the **MICRA** single-room air handling units is their ability to recover heat to the premises (up to 92%) due to a specially designed aluminium recuperator.

Heat recovery is based on use of extract air heat energy for heating of intake fresh air from outside. In view of permanent heat losses in the room use of heat recovery is the most useful technology for cost and energy saving.

▶ VERSATILE

The **MICRA** single room air handling units with heat recovery are applicable at any project stage and suitable for installation in any room where installation of centralized ventilation devices is unfeasible:

- complex ventilation system for brand new construction;
- reconstruction of existing buildings and premises;
- ordinary scheduled repair in ready-made premises.

▶ SIMPLE AND EASY TO USE

The single room air handling units with heat recovery **MICRA** have compact sizes and are designed for mounting on outer wall from inside. Two \varnothing 125 mm through-the-wall openings in the wall is everything you need for mounting. After mounting they are covered with the decorative unit casing. Install a double outer hood on outer side of the wall to prevent direct water ingress and foreign objects inside the unit.



MICRA UNITS WILL SUPPLY FRESH AIR WITH MINIMUM ENERGY DEMAND AND SURPRISE

YOU WITH THEIR SILENT OPERATION



Sensor speed switch
(Micra 60 A4)



Three-position speed switch
(Micra 60 A3)

The single room air handling unit with heat recovery for balanced energy saving single room ventilation of flats, cottages and commercial premises. No need to connect air ducts.

FEATURES

- Efficient heat recovery ventilation for separate rooms (premises)
- Plate counter flow plastic heat exchanger with recuperating efficiency up to 79%
- EC fans with low energy demand and electrical safe voltage 12 V
- Integrated automatics with three operation modes
- Silent operation (22-29 dBA)
- Air cleaning with two G4 built-in filters
- Easy mounting
- Suitable for continuous operation
- Pulser power supply unit for wide range of power supply voltage 100-240 V and frequency 50-60 Hz.

OPERATING LOGIC

Fresh intake air from outside moves through the filter and the heat exchanger and is supplied to the premise with a supply exhaust fan. Warm stale air from the room moves through the filter and recuperator and then is exhausted outside with an exhaust axial fan. Heat energy of warm stale extract air is transferred to cold intake air flow from outside in the heat exchanger. Heat energy utilization results in reducing heat energy losses and operating costs for heating in cold season. The intake and extract air flows are fully separated and pollutants, odours and microbes contained in extract air are not transmitted to supply air.

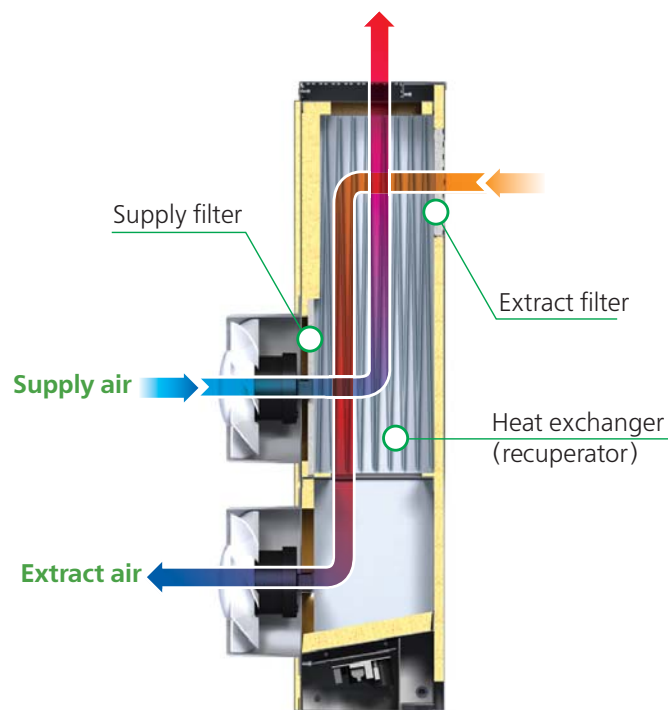

CONTROL AND OPERATION MODES

The unit is equipped with a sensor speed switch or a three-position speed switch.

Automatic system enables three operation modes:

1. Minimum	30 m ³ /h	noise level 22 dB(A)
2. Medium	45 m ³ /h	noise level 25 dB(A)
3. Maximum	60 m ³ /h	noise level 29 dB(A)

▶ CASING (1)

Polymer coated metal casing decorated with mirror stainless steel. 15 mm penophole thermal and sound insulating layer. Modern unit design makes it match well with any interior. Removable front panel provides easy access for the unit servicing, i.e. for filter cleaning or replacement. Air is supplied to the room and exhausted outside through two Ø125 mm air ducts.

▶ AIR FILTRATION (2)

Two G4 built-in filters provide cleaning of supply and extract air. The filters serve to ensure supply of fresh air free of dust, pollen, insects and protect the unit from soiling.

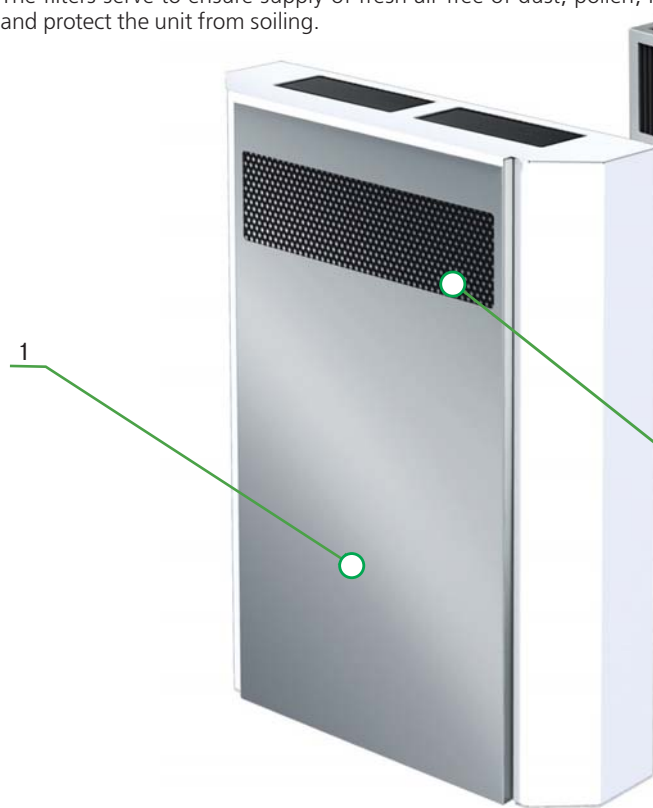

▶ CONTROL UNIT (4)

The unit is powered through an integrated pulser unit with a wide range of supply voltage from 100 V to 240 V and frequency from 50 to 60 Hz. The power unit has integrated protection circuit for various emergencies including short circuit, overload, voltage jumps, reverse polarity in output circuits. The versatile characteristics of the power unit enable the product use in various countries and ensure its stable operation in power grid with wide tolerances of electricity standard.

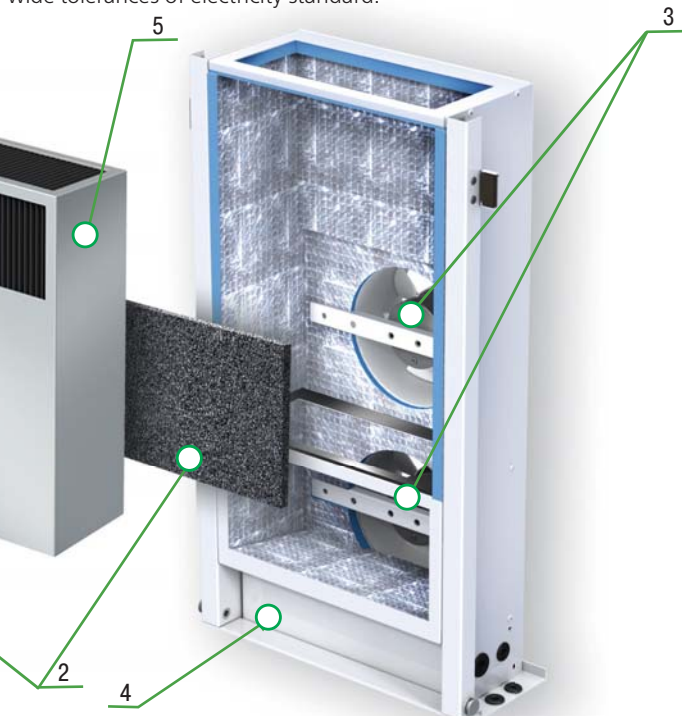

▶ HEAT EXCHANGER (RECUPERATOR) (5)

The unit is equipped with a high-tech plate counter-flow aluminium heat exchanger. The heat exchanger utilizes heat energy of extract air flow to warm up cold air flow. Recuperating efficiency reaches 79%. Joint operation of the single room air handling unit with heat recovery **MICRA** with air conditioners is not only the most efficient way to arrange desirable indoor microclimate but considerable cost saving because the recuperator saves heat in winter and cool in summer.

▶ AIR SUPPLY AND AIR EXTRACT (3)

Axial EC fans provide air supply and air extract. Due to EC technologies the single room air handling unit with heat recovery is featured with low energy demand. The fans are powered by electric safe low voltage 12 V. The fan motors are equipped with built-in thermal overheating protection and ball bearings for longer service life.

▶ FREEZING PROTECTION

Unit has integrated freeze protection system. During cooling of extract air some condensate can appear in the unit. To prevent recuperator freezing the unit is equipped with electronic freezing thermostats that switch supply fan off. After that warm stale air warms the recuperator up to required temperature.

VENTILATION SYSTEM ARRANGEMENT EXAMPLE

Install **MICRA 60** unit in any room where ventilation is required. One unit provides efficient ventilation for the area up to 24 m². Mount the single room air handling unit with heat recovery MICRA on the front wall from inside. The minimum wall thickness is 100 mm. To attain the maximum energy efficiency of a ventilation system based on the Micra 60 units we suggest using it in combination with iFan, which extracts stale air from a bathroom according to the humidity sensor readings.

First mark the holes on the wall for the air ducts with the paper master plate (included into delivery set and into MK1 and MK2 set (page 13)). After holes are drilled install the plastic air ducts inside the holes.

Install the outer hood (included into the MK2 set or purchased separately (NB set)) on outer side of the wall to prevent ingress of water and foreign objects inside the unit.

Mount the unit with its branch pipes directed toward the plastic air ducts. The unit is supplied with a pre-wired power cable and a socket. The unit may be connected to the fixed wiring system through terminal leads if required.

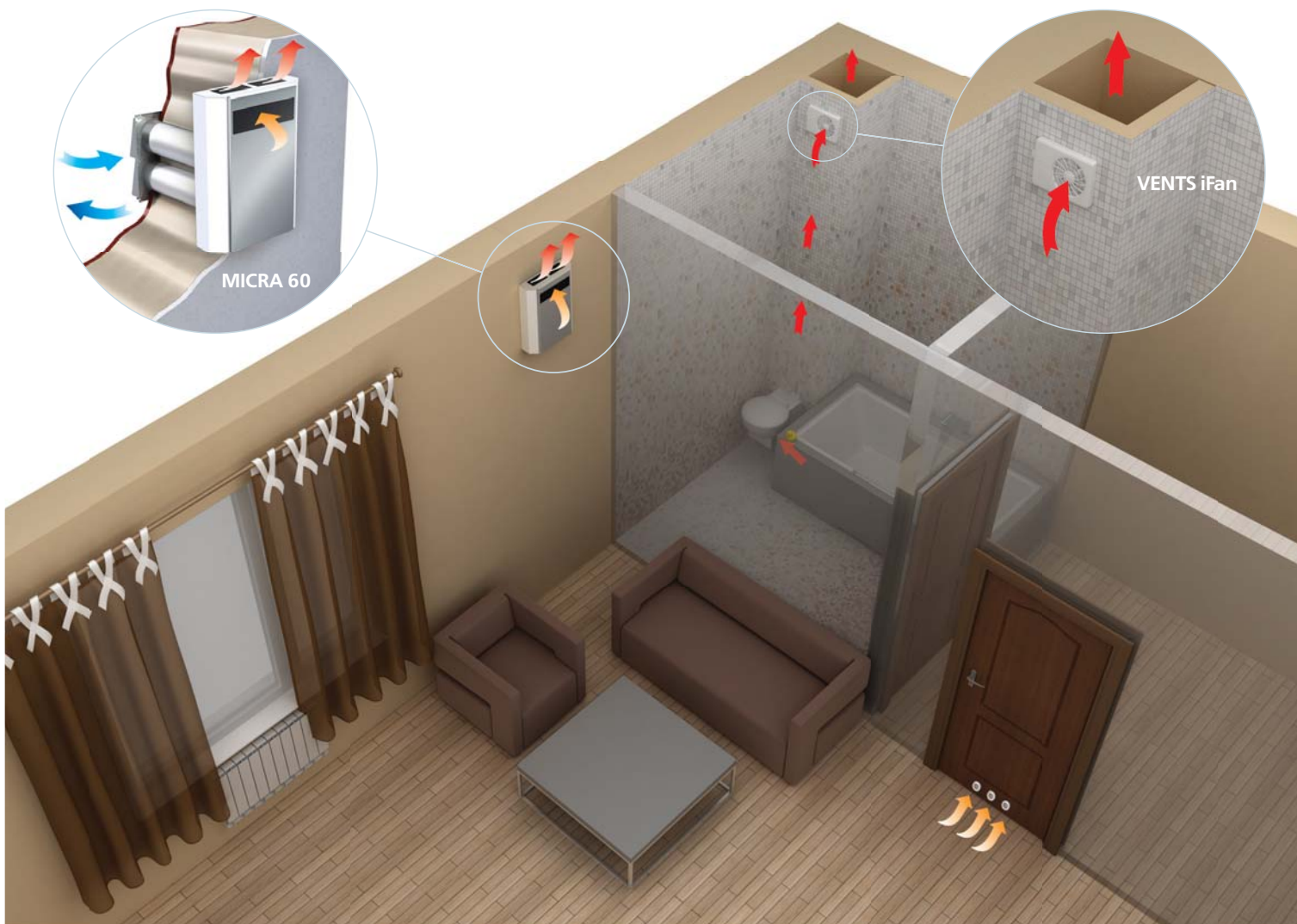
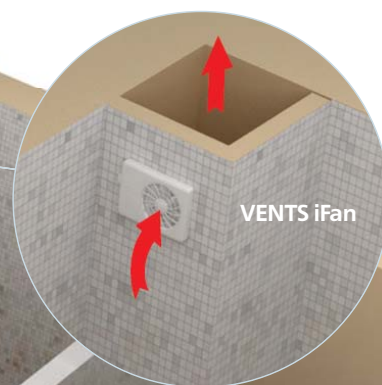
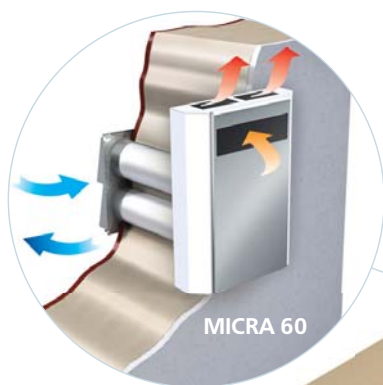

TECHNICAL DATA

Model	MICRA 60		
Speed	1	2	3
Voltage [V/50 Hz]	100-240/50-60 Hz		
Power [W]	4,2	9,6	15,4
Air capacity [m ³ /h]	30	45	60
Heat recovery efficiency	79%	74%	70%
Rotation speed [min ⁻¹]	1165	1720	2685
Sound pressure level at 3 m distance [dBA]	22	25	29
Ingress protection rating	IP22		

OVERALL DIMENSIONS [mm]

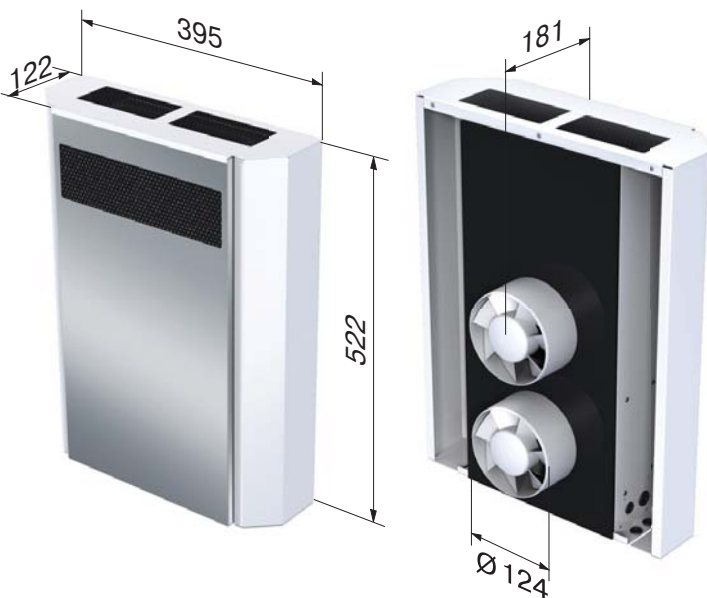

ACCESSORIES

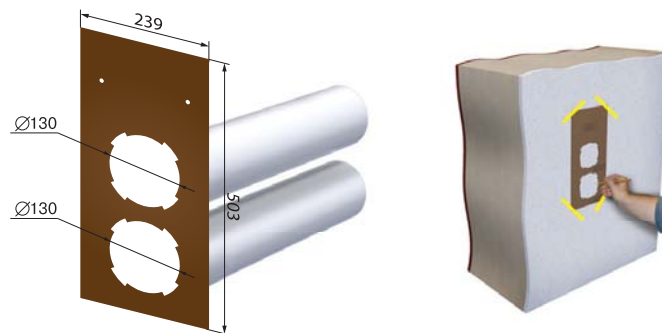

MK1 MICRA 60

used to facilitate mounting and ensure correct alignment of the unit branch pipes with the air ducts:

- two plastic air duct 125 mm 500 mm long;
- paper master plate (2 pcs).



NB MICRA 60 outer ventilation kit:

- double outer metal hood.

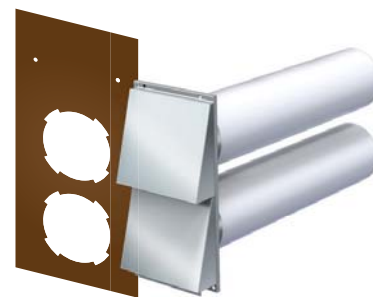

MK2 MICRA 60 mounting kit:

- two plastic air duct 125 mm 500 mm long;
- paper master plate;
- outer ventilation kit NB Micra 60.



Single-room air handing unit with air warming up function. It has easy mounting without air ducts.

OPERATING LOGIC

The intake air from outside flows through the filter and the heat exchanger and is supplied to the room with the supply centrifugal fan. Warm stale air from the room flows through the filter and the heat exchanger and is exhausted outside through the wall by the exhaust centrifugal fan. In the heat exchanger heat energy of warm extract air from the room is transferred to clean cold air flow from outside. Heat exchange results in minimization of heat losses and lower heating costs. The extract and supply air flows are fully separated, so no contaminations, odours and microbes come to supply air flow.

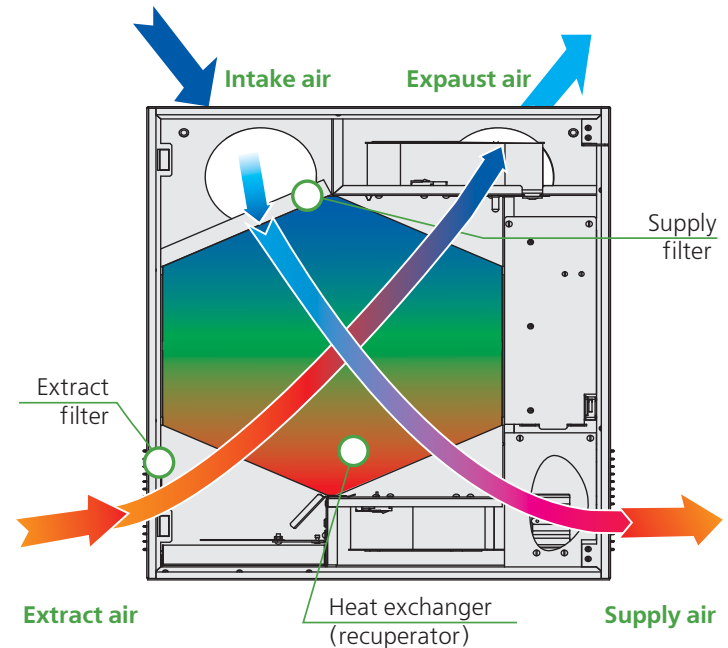

FEATURES

- Efficient supply and exhaust ventilation of separate premises (rooms)
- Posistor 350 W air heater with overheating protection
- Polystyrene plate counter-flow heat exchanger with recuperation efficiency 82-92%
- EC fans with low energy demand (9 to 40 W)
- Integrated automation with 3 operation modes (from 60 up to 150 m³/h)
- Silent operation (30-38 dB(A))
- Air cleaning with two built-in G4 filters
- Easy mounting
- Compact sizes

CONTROL AND OPERATION MODES

The unit is equipped with a control panel. The delivery set includes a remote control panel. The control system supports the following 3 operation modes:

- **1 speed:** air capacity 60 m³/h and air warming up function;
- **2 speed:** air capacity 105 m³/h and air warming up function;
- **3 speed:** air capacity 150 m³/h and air warming up function.

The following functions are available:

- extra heating of supply air;
- high speed activation timer adjustable from 20 to 60 minutes;
- fan speed adjustment;
- week-scheduled operation;
- filter replacement and alarm indication.

▶ CASING (1)

Metal polymer coated casing decorated with mirror-polished stainless steel. 10 mm foamed synthetic rubber layer provides heat- and sound-insulation. The modern unit design let it match well with any interior type.

▶ AIR FILTRATION (3)

Supply and exhaust air flows are cleaned with two built-in G4 filters. The filters serve to provide supply of fresh air free of dust, insects and prevent the unit components from soiling.

▶ CONDENSATE DRAIN PAN (4)

Some condensate that may be generated during heat recovery process is collected in a special drain pan. As the drain pan is filled with condensate, the unit switches automatically off which is confirmed by a light indicator on the control panel.

▶ HEAT EXCHANGER (5)

The unit incorporates a high-tech plate counter-flow polystyrene heat exchanger with heat exchange efficiency 82-92%. In winter period the heat exchanger utilizes heat energy of extract air to warm up intake air and decrease the operating load on the heating system. In summer period supply air is cooled down by colder intake air.

▶ HEATER (6)

The unit is equipped with a ceramic heater which is used to warm up supply air up to the comfortable air temperature. Heater is operational economy, fire safety (no overheating), environmental friendliness, self regulation, high electric durability, high specific power, easy and reliable maintenance. The heater efficiency is reaches 90-95%.

▶ FREEZING PROTECTION

The air handling unit MICRA 150 E is equipped with a built-in freezing protection. The electronic freeze protection is applied to prevent condensate freezing during cold outside temperatures. If exhaust air temperature drops down below the set point, the supply fan is stopped. Warm extract air warms the heat exchanger up and the exhaust air temperature rises. After that the supply fan is turned on and the unit reverts to the previous operation mode.

▶ AIR SUPPLY AND EXHAUST (2)

High-efficient EC motors with external rotor and forward curved blades are designed for air supply and exhaust. The fan motors have built-in overheating protection and ball bearings for longer service life. Due to EC technologies Micra 150 E is featured with low energy demand and reliable operation.

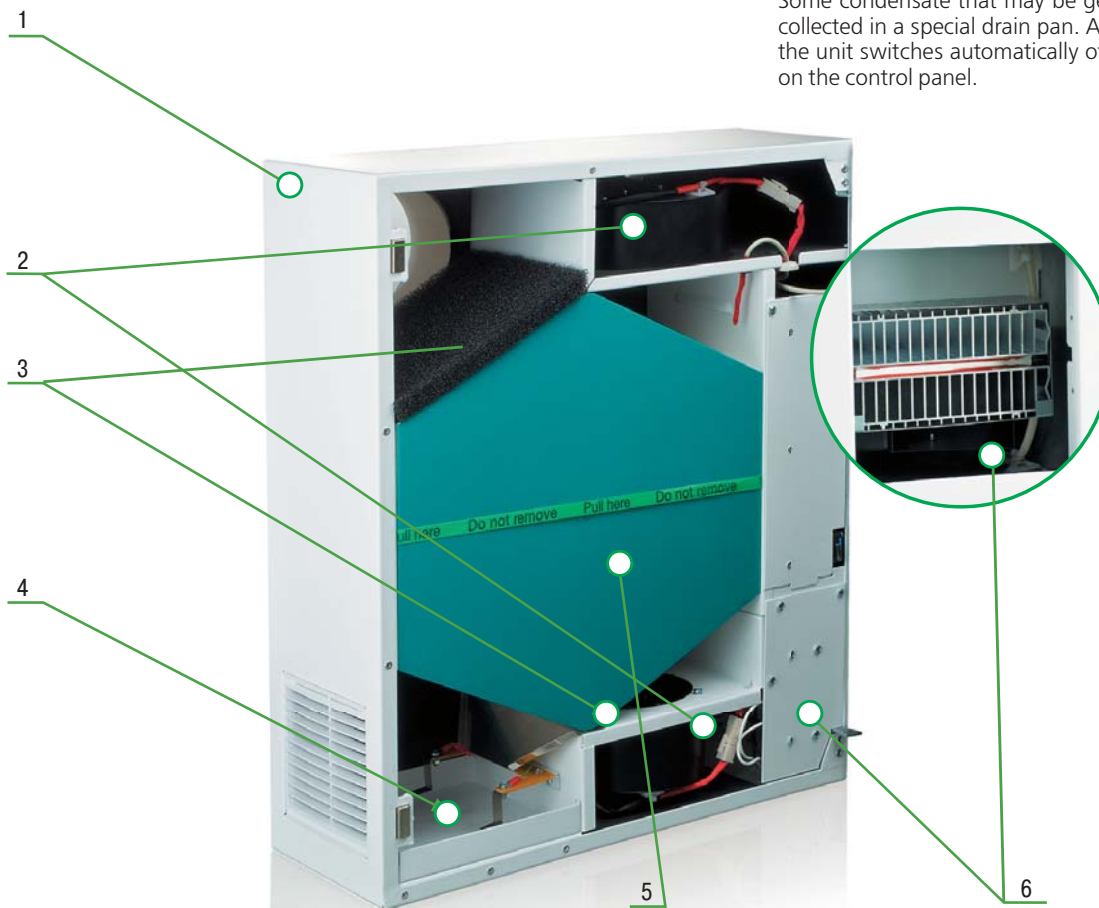

VENTILATION SYSTEM ARRANGEMENT EXAMPLE

Install one or several **MICRA 150 E** unit in each premise to be ventilated. One unit is capable to provide efficient ventilation of up to 60 m² area. The air handling unit **MICRA 150 E** is mounted on a face wall from inside. The wall thickness from 100 mm.

First mark the holes for the air ducts with a cardboard master plate included into the delivery set. Insert the air ducts into the holes. Mount a double metal hood on outer wall side to protect the unit from water ingress and outer objects. While mounting the unit direct the branch pipes to the plastic air ducts and fix it to the wall with dowels and screws. The unit is supplied with a pre-wired power cable and a socket. The unit may be connected to the fixed wiring system through terminal leads.

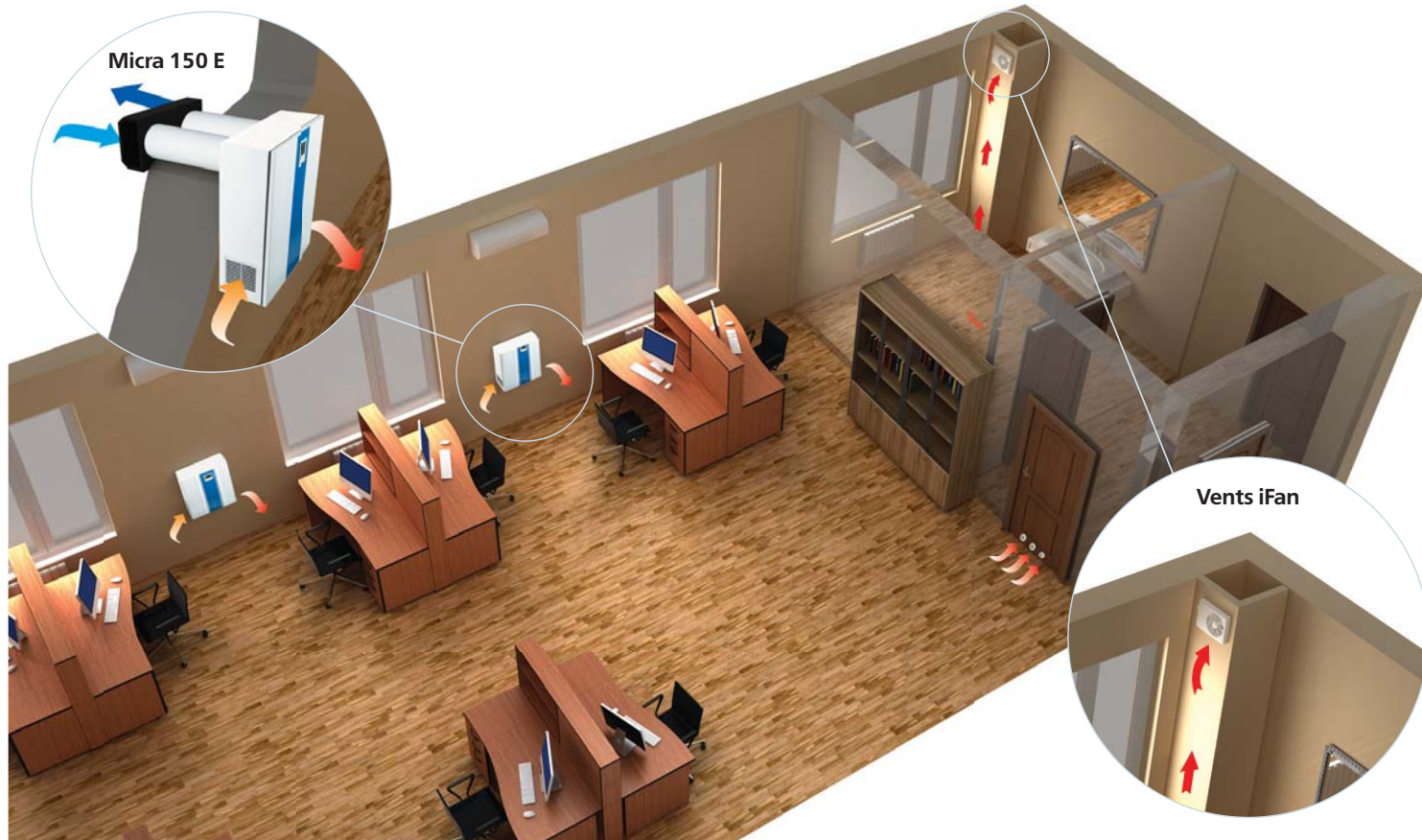
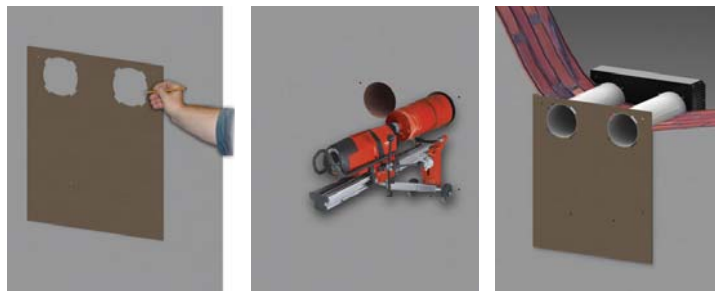

Model	MICRA 150 E		
Ventilation mode	1	2	3
Voltage [V]	230/50 Hz		
Maximum fan power [W]	9	16	40
Heater power [W]	350		
Maximum unit current (including heater operation) [A]	1,68		
Air capacity [m ³ /h]	60	105	150
RPM [min ⁻¹]	450	780	2000
Noise level at 3 m distance [dB(A)]	30	35	38
Heat recovery efficiency	92	87	82
Ingress protection rating	IP 22		

OVERALL DIMENSIONS [mm]



ACCESSORIES

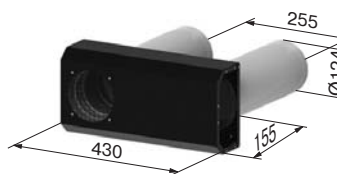

Mounting kit **MK MICRA 150**:

- two plastic air ducts (Ø 125 mm, length 500 mm);
- double outer metal hood.

