

		KRVZ	KRVZS	KRVSM	KRVIN	KRVT	KRVTZ	KRR
1	Ramka licująca	•	•	•	•	•	•	
2	Kratka ruszt	•	•	•				
3	Maskownica	•	•	•	•	•	•	
4	Maskownica LOFT							•
5	Kaseta dolotowa prosta	•	•	•	•	•	•	
6	Kaseta dolotowa boczna	•	•	•	•	•	•	
7	Kaseta dolotowa podwójna	•	•	•	•	•	•	
8	Kaseta dolotowa podwójna boczna	•	•	•	•	•	•	

1. RAMKA LICUJĄCA



KRV-RL AxB - ML.a

- kolor (B- biała, CZ- czarna)
- blacha czarna malowana proszkowo
- typ kratki KRV
- ramka licująca

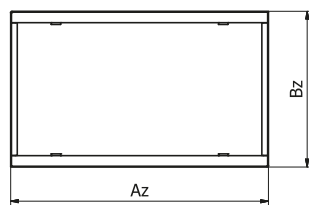
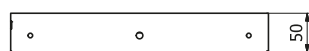

* zestaw nie zawiera kratki KRV

Typ kratki KRV AxB [mm]	Wymiar ramki [mm]		Waga [kg]
	Az	Bz	
220x95	223	98	0.2
200x145	203	148	0.2
190x170	193	173	0.2
240x170	243	173	0.2
220x220	223	223	0.3
325x170	328	173	0.3
325x195	328	308	0.3
450x170	453	173	0.4
450x220	453	223	0.4
450x240	453	243	0.4

2. KRATKA RUSZT

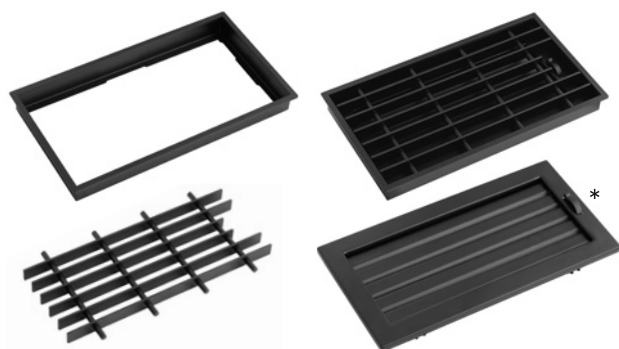

KRV-RL AxB - ML.a

- kolor (B- biała, CZ- czarna)
- blacha czarna malowana proszkowo
- typ kratki KRV
- kratka ruszt

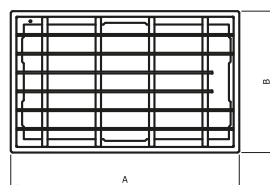

* zestaw nie zawiera kratki KRV

Typ kratki KRV AxB [mm]	Wymiary [mm]				Waga* [kg]
	A	B	C	D	
325x170	342	187	328	173	3.0
325x195	342	212	328	198	3.3
450x170	467	187	453	173	4.0
450x240	467	257	453	243	5.0

3. MASKOWNICA

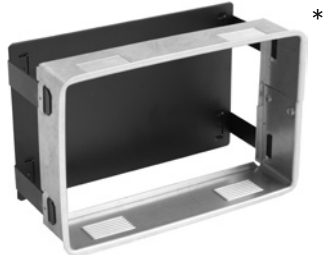

*

* zestaw nie zawiera ramki kratki (ramka jest w komplecie z kratką)

Typ kratki KRV AxB [mm]	Wymiary [mm]		Waga [kg]
	A	B	
200x145	180	120	0.2
190x170	170	145	0.2
240x170	220	145	0.2
220x220	200	195	0.3
325x170	305	145	0.3
325x195	305	170	0.3
450x170	430	145	0.4
450x220	430	195	0.5
450x240	430	215	0.5

MKKRV AxB - ML.CZ

blacha czarna malowana proszkowo na kolor czarny
typ kratki KRV
maskownica

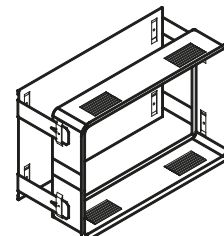
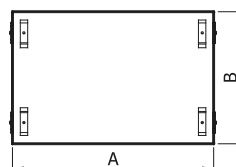

4. MASKOWNICA LOFT



Typ kratki LOFT	Wymiary [mm]		Waga [kg]
	A	B	
350x60	353	65	0.3
650x60	653	65	0.6
1000x60	1003	65	0.9
350x100	353	103	0.5
500x100	503	133	0.6
650x100	653	103	0.8
800x100	803	103	0.9
1000x100	1003	103	1.1
650x150	653	155	0.9
350x150	353	155	0.6

MKKRR ...x... - ML.CZ

blacha czarna malowana proszkowo na kolor czarny
typ kratki LOFT
maskownica

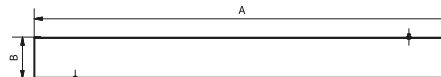
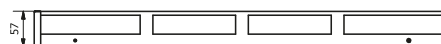

5. KASETA DOLOTOWA PROSTA



Typ kratki KRV AxB [mm]	Wymiary [mm]		d „spiro” [mm]	Waga [kg]
	A	B		
200x145	180	120	80-110	0.2
190x170	170	145	80-150	0.2
240x170	220	145	80-150	0.3
220x220	200	195	80-180	0.3
325x170	305	145	80-150	0.3
325x195	305	170	80-150	0.3
450x170	430	145	80-150	0.4
450x220	430	195	80-180	0.5
450x240	430	215	80-200	0.5

KDKRV AxB / d - ML.CZ

blacha czarna malowana proszkowo na kolor czarny
średnica „spiro”
typ kratki KRV
kasecja doletowa prosta

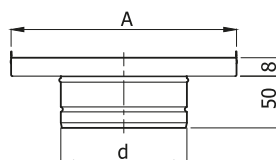
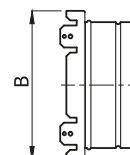
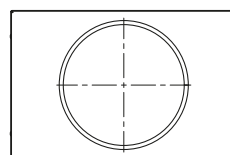

6. KASETA DOLOTOWA BOCZNA



Typ kratki KRV AxB [mm]	Wymiary [mm]		d „spiro” [mm]	Waga [kg]
	A	B		
200x145	180	120	80-110	0.6
190x170	170	145	80-150	0.6
240x170	220	145	80-150	0.7
220x220	200	195	80-180	0.8
325x170	305	145	80-150	0.9
325x195	305	170	80-150	1.0
450x170	430	145	80-150	1.4
450x220	430	195	80-180	1.4
450x240	430	215	80-200	1.5

KDBKRV AxB / d - ML.CZ

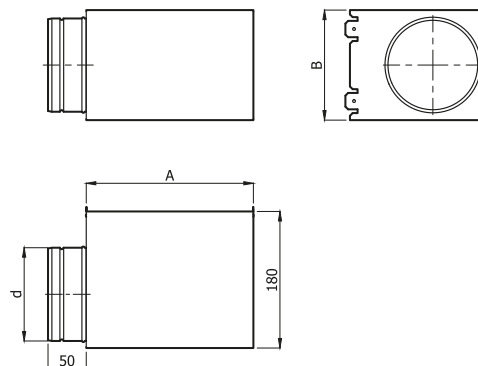
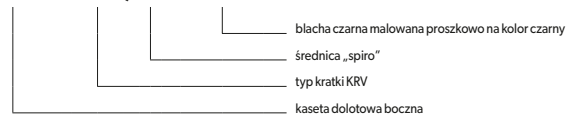

7. KASETA DOLOTOWA PROSTA PODWÓJNA



Typ kratki KRV AxB [mm]	Wymiary [mm]			d „spiro” [mm]	Waga [kg]
	A	B	C		
450x170	430	145	225	2x80-150	0.5
450x220	430	195	225	2x80-180	0.5
450x240	430	215	225	2x80-180	0.5

KDKRV AxB / 2xd - ML.CZ

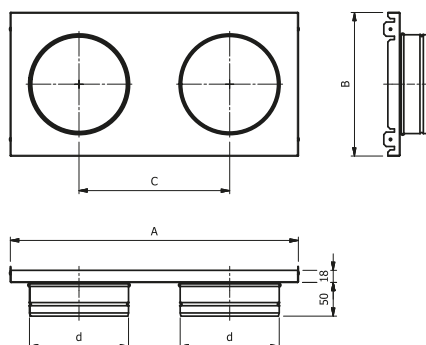
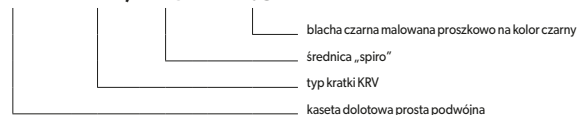

8. KASETA DOLOTOWA BOCZNA PODWÓJNA



Typ kratki KRV AxB [mm]	Wymiary [mm]			d „spiro” [mm]	Waga [kg]
	A	B	C		
450x170	430	145	225	2x80-150	1.3
450x220	430	195	225	2x80-180	1.4
450x240	430	215	225	2x80-180	1.4

KDBKRV AxB / 2xd - ML.CZ

